

Les Formes

Les Solids

Coupe, Cole, Colorie

Freebie

3D shapes

Cut, Glue, Color

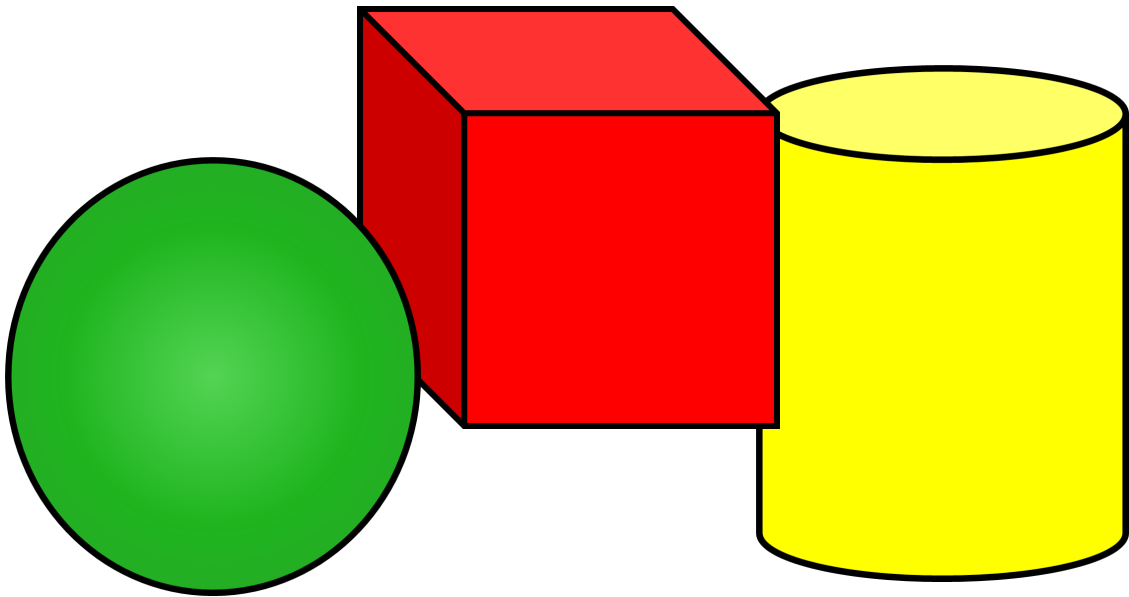

How to use this resource:

Page 3—Students color in shapes as directed and count the number of each shape type.

Page 4– Students cut and glue shapes into one of the two columns following the rule. They can cut out shapes on the bottom of the page or shapes from magazines.

Page 5– Students create their own sorting rule and sort shapes into the two categories. Again students can cut out shapes at the bottom or find shapes in magazines.

Nom: _____

Colories les formes la couleur indiquer.

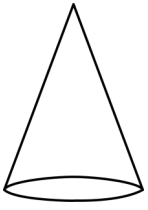

les cônes jaunes

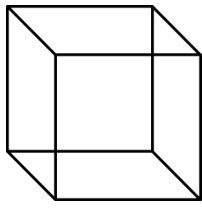

les cubes rouges

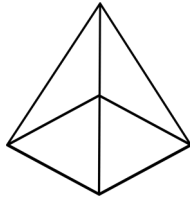

les pyramides orange

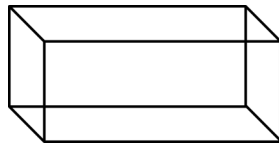

les parallélépipèdes bleus

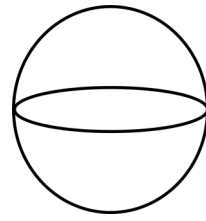

les sphères vertes

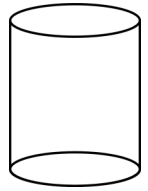

les cylindres noirs

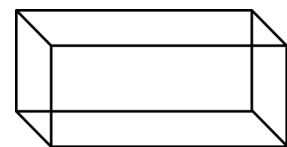
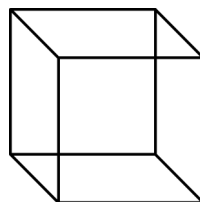
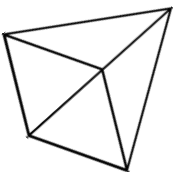
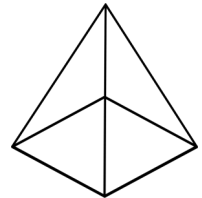
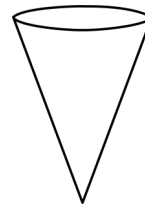
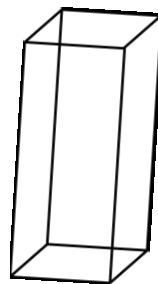
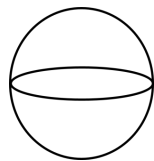
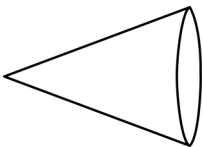
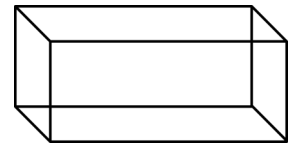
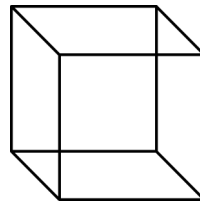
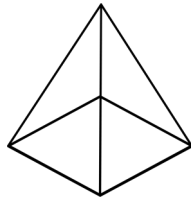
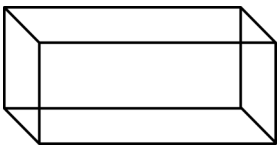
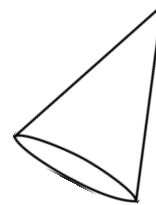
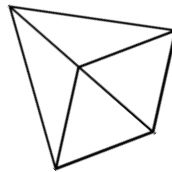
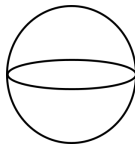
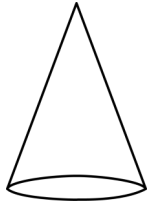
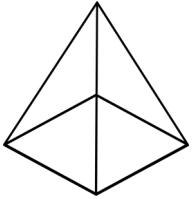
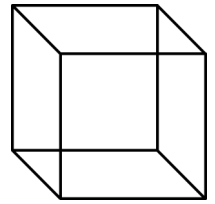
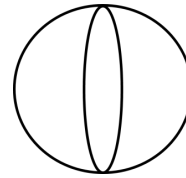
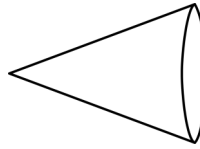
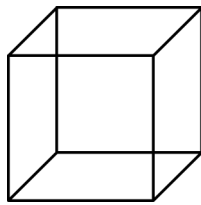
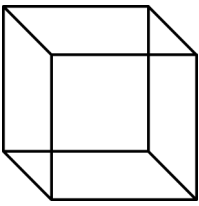

Il y a ___ cônes , ___ cubes ___ pyramides , ___ parallélépipèdes ___ sphères et ___ cylindres.

Nom: _____

Il y a des coins	Il n'y a pas de coin

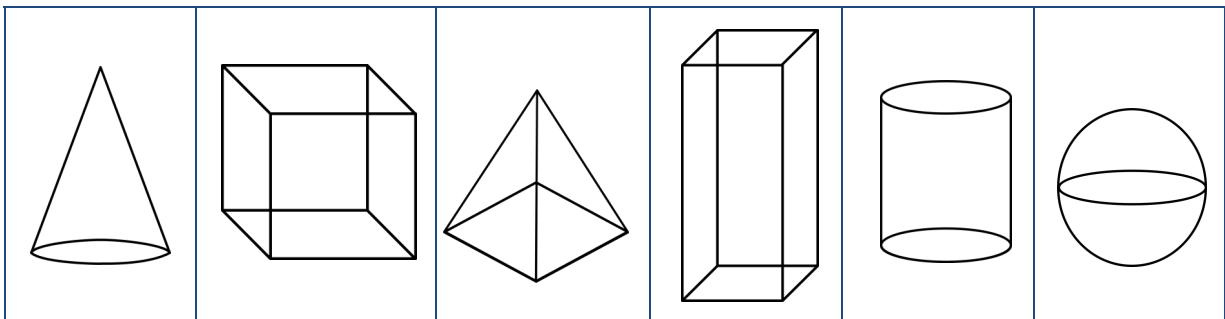

Nom: _____

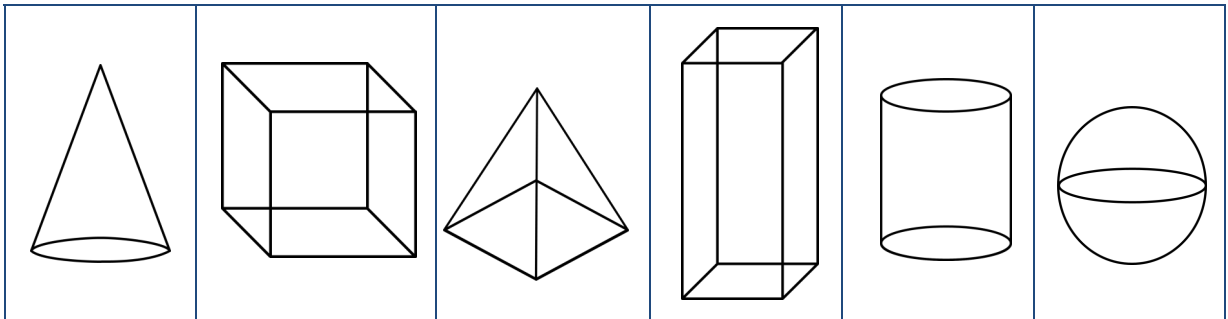

Created by La Classe de Mme Hawtree May 2015



Clip Art by:

